

Resistance thermometer Pt 100 with screw-in thermowell or with flange connection, Type Series GA251 .



Features

- Pt 100 connection in 3- or 4-wire technology
- Measuring insert 1 x Pt 100 or 2 x Pt 100
- Measuring insert interchangeable
- Process connection
 - for screw-in
 - with flange connection
- Various thermowell designs available

Options

- Explosion protection
- Transmitter can be integrated
- Classification per SIL 2
- Measuring insert for In-process calibration

Application area

- Chemical and petrochemical industry
- Machinery construction

Application

The resistance thermometer is suited for operation on tanks and pipes. All standard types of process connections are available. The change in resistance, dependent on the measurement temperature, can be detected by a transmitter and converted into a standardized signal. A variety of transmitters for head mounting is available for different applications. For In-process calibration the integration of a special measuring insert with additional test pipe is possible (data sheet T4-025-45, Type GA3100, reference sensor: data sheet T4-025-46, Type GA3110).

Technical Data

Mechanical design

Measuring insert interchangeable with connection head and neck-tube

Connection head

selective

- model B, cap with 2 slotted screws, mat. aluminium, IP 54
- model BUZH, high spring cover with slotted screw, mat. aluminium, IP 65
- field housing Ø 60 mm, screw cap, stainless steel mat.-no. 1.4305 (303), IP 67 further connection heads upon request

Thermowell

material stainless steel mat.-no. 1.4571 (316Ti). Special materials upon request.

Thermowell 9 x 1 bzw. 11 x 2 mm length see order details

option: certification of material testing per DIN EN 10204

Upon request a calculation for thermowells can be made (for static or dynamic application) with certificate.

Measuring insert

Material stainless steel, interchangeable, DIN 43735

length of measuring insert l_s = thermowell length L + 10 mm

Ø of meas. insert depending on thermowell, standard 6 mm

resistor Pt 100 according to DIN EN 60751

Optional: Measuring insert with connection socket per DIN 43735 and with additional test pipe for In-process calibration.

Material: stainless steel, mat.-no. 1.4571 (316 Ti) (see data sheet T4-025-45)

Type of sensor/class/circuit

see order details

Ex-approval

For standard measuring insert:

BVS 04 ATEX E 144 X

Ex II 2 G Ex ia IIC T4/T6

$U_i \leq 30$ V

$P_i \leq 200$ mW

More technical information see XA_002

For In-process calibration:

IBExU 13 ATEX 1017 X

Ex II 2 G Ex ia IIC T6-T1 Gb

$U_i \leq 30$ V

$P_i \leq 750$ mW

L_i max. 10 µH/m

C_i max. 500 pF/m

More technical information see XA_003.

Functional safety

per EN 61508, classification per SIL 2; without transmitter, only

Accuracy of the measuring resistor

class A according to EN 60751

more Technical Data

Process connections

for screw-in/insertion/weld-in

- G 1/2 B, G 3/4 B
 - G 1 B
 - M 20 x 1.5
 - 1/2" NPT, 3/4" NPT
- with flange connection
- DN50 PN10/40 model B1 (DIN EN 1092-1)
 - DN25 PN10/40 model B1 (DIN EN 1092-1)

Further process connections upon request
material: stainless steel mat. no. 1.4571 (316Ti)

Integration of transmitter

suitable Pt 100 transmitters can be integrated into the connection head.

Options:

- a) instead of terminal block

- b) mounting in the spring cover of the connection head BUZH
see product group T4 for analog or digital transmitters

LED-on-site indication

programmable LED-on-site indication for stainless steel field housing (Ø 60 mm), see data sheet M6-031.

Dimensions

connection heads

model B, cap with 2 slotted screws
mat. aluminium, IP 54

model BUZH, high spring cover with slotted screw,
mat. aluminium, IP 65

connection head field housing, screw cap,
mat. stainless steel, IP 67

connection head field housing, screw cap with opening,
mat. stainless steel, IP 67

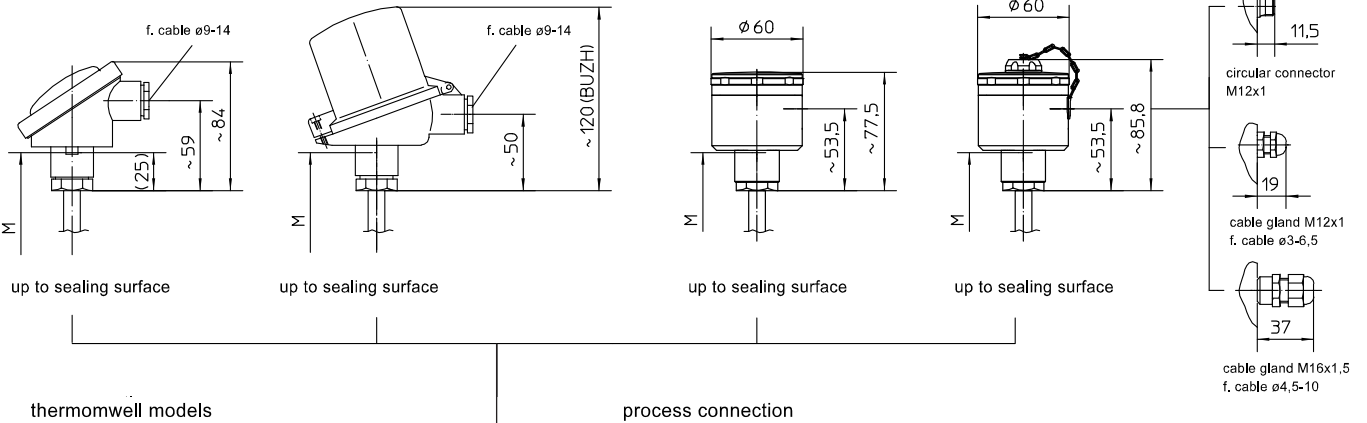

thermowell models

process connection

thermowell according to DIN 43772:

insertion/
welding

insertion/
welding

screw-in

screw-in

flanged

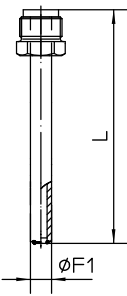

model 2

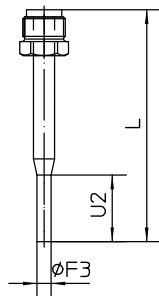

similar model 3
with reduced tip

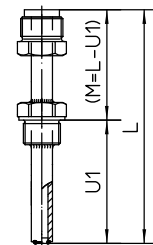

model 2 G/3 G
parallel thread
G1/2B
G3/4B
G1B
M20x1,5

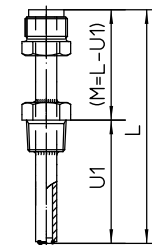

model 2 G/3 G
conical thread
1/2"NPT
3/4"NPT

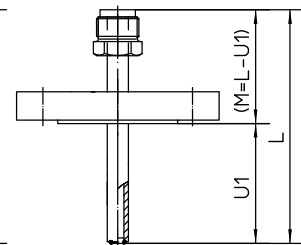

model 2 F/3F
DIN-flange
DN50/PN10/40
model B1 (DIN EN 1092-1)
DN25/PN10/40
model B1 (DIN EN 1092-1)

Remark: neck tube M > 60 mm



Connection diagram

connection head

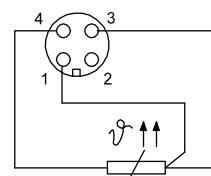
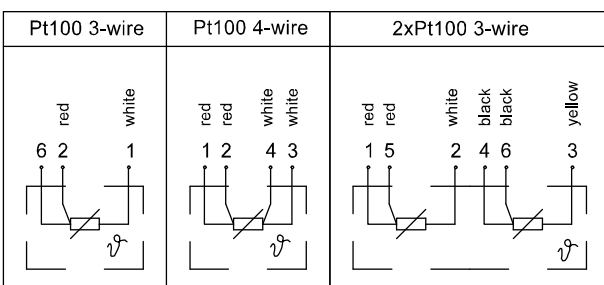
circular connector
M12x1



Order Details - please give additional specifications for models not listed -

Resistance Thermometer Pt 100 with screw-in thermowell or with flange connection															
design	· with thermowell				GA251										
ex-protection	· without				0										
	· explosion protection, type of ex-protection s. below				1										
process connection	· without, for insertion or for welding				A01										
	· G 1/2 B				A10										
	· G 3/4 B				A11										
	· G 1 B				A12										
	· M 20 x 1.5				A13										
	· 1/2" NPT				A15										
	· 3/4" NPT				A16										
	· flange DN25 PN 10/40 model B1 (DIN EN 1092-1)				A21										
· flange DN50 PN 10/40 model B1 (DIN EN 1092-1)				A22											
material process conn.	· stainless steel mat.-no. 1.4571 (316Ti)				1										
	· varying				9										
thermowell length total L	length L	meas. insert L _s													
	95 mm	105 mm						B10							
	115 mm	125 mm						B13							
	130 mm	140 mm						B16							
	180 mm	190 mm						B19							
	195 mm	205 mm						B22							
	245 mm	255 mm						B28							
	265 mm	275 mm						B31							
	305 mm	315 mm						B37							
	365 mm	375 mm						B40							
	395 mm	405 mm						B43							
	425 mm	435 mm						B46							
	515 mm	525 mm						B49							
	545 mm	555 mm						B52							
varying							B99								
thermowell Ø and model	· F1 = 9 mm, thermowell 9/7, model 2 per DIN, standard								C12 ...						
	· F1 = 11 mm, thermowell 11/7, model 2 per DIN								C13 ...						
	· 9/7, reduced tip F3 = Ø 5x20 mm, ID 3.5 mm								C16 ...						
	· 12, reduced tip F3 = Ø 9x40 mm, ID 6.5 mm								C17 ...						
	as in writing								C99 ...						
thermowell material	stainless steel mat.-no. 1.4571 (316Ti)								1						
	varying								9						
immersion length U1 ¹	length in mm (e.g. 160 for 160 mm), U _{max} = L - 60 mm								...						
	varying, as in writing								999						
measuring insert as per DIN 43735 (class A)	diameter, design, material	meas. element		operating range		test pipe									
	· 6 mm, rigid, st. steel, standard	thin film		-50...+400 °C		-		D2-M22							
	· 6 mm, sheathed element, st. steel	ceramic		-200...+600 °C		-		D6-M21							
sensor type	· 6 mm, rigid, st. steel (In-process)				-50...+400 °C		28 mm ²		D22-M22						
	· 1 x Pt 100 in 3-wire technology, standard								N2						
	· 1 x Pt 100 in 4-wire technology								N3						
connection head	· model B		electrical connection cable gland M20x1.5						T11						
	· model BUZH		nickel plated brass, cable Ø 9-14						T15						
	· field housing	cable gland	polyamide black		cable Ø 3-6.5				T47						
			st. steel		cable Ø 4.5-10				T47.40						
	with circular connector M12x1								T47.51						
	· field housing with additional opening for reference sensor	cable gland	polyamide black		cable Ø 3-6.5				T49						
			st. steel		cable Ø 4.5-10				T49.40						
									T49.21						
additional features (to be indicated in case of need, only)															
type of ex-protection	·  II 2G Ex ia IIC T4/T6 ³ , BVS 04 ATEX E 144 X (standard measuring insert)								S68						
	·  II 2G Ex ia IIC T6-T1 Gb, IBExU 13 ATEX 1017 X (In-process calibration)								S75						
incl. transmitter (pls specify separately)	· mounting on the measuring insert (instead of terminal block)								Z1						
	· mounting in the spring cover of the connection head BUZH								Z2						
material certificate per DIN EN 10204-3.1								W1020							
functional safety per EN 61508, classification per SIL 2								W2604							
transmitter with resistance thermometer calibrated, incl. calibration certificate with 3 meas. points								W4057							
order code (example):					GA2510	A101	B37	C121160	D2-M22	N2	T47				

¹ not possible with process connection A01 (insertion/welding)² for In-process calibration only (no classification per SIL 2)³ only with sheathed element